

# International IOR Rectifier

## 16CTU04SPbF 16CTU04-1PbF

### Ultrafast Rectifier

#### Features

- Ultrafast Recovery Time
- Low Forward Voltage Drop
- Low Leakage Current
- 175°C Operating Junction Temperature
- Lead-Free ("PbF" suffix)

$t_{rr} = 60\text{ns}$
$I_{F(AV)} = 16\text{Amp}$
$V_R = 400\text{V}$

#### Description/ Applications

International Rectifier's FRED.. series are the state of the art Ultra fast recovery rectifiers specifically designed with optimized performance of forward voltage drop and ultra fast recovery time.

The planar structure and the platinum doped life time control, guarantee the best overall performance, ruggedness and reliability characteristics.

These devices are intended for use in the output rectification stage of SMPS, UPS, DC-DC converters as well as free-wheeling diode in low voltage inverters and chopper motor drives.

Their extremely optimized stored charge and low recovery current minimize the switching losses and reduce over dissipation in the switching element and snubbers.

#### Absolute Maximum Ratings

Parameters	Max	Units
$V_{RRM}$ Peak Repetitive Peak Reverse Voltage	400	V
$I_{F(AV)}$ Average Rectified Forward Current	Per Leg 8	A
	Total Device, (Rated $V_R$ ), $T_C = 155^\circ\text{C}$ Total Device 16	
$I_{FSM}$ Non Repetitive Peak Surge Current, $T_C = 25^\circ\text{C}$	100	
$I_{FRM}$ Peak Repetitive Forward Current (Rated $V_R$ , Square wave, 20KHz), $T_C = 155^\circ\text{C}$	16	
$T_J, T_{STG}$ Operating Junction and Storage Temperatures	- 65 to 175	$^\circ\text{C}$

#### Case Styles

16CTU04SPbF

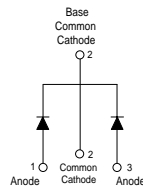

D<sup>2</sup>PAK

16CTU04-1PbF

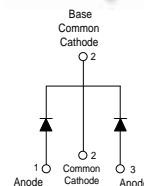

TO-262

**Electrical Characteristics @ T<sub>J</sub> = 25°C, Per Leg (unless otherwise specified)**

Parameters	Min	Typ	Max	Units	Test Conditions
V <sub>BR</sub> , V <sub>r</sub> Breakdown Voltage, Blocking Voltage	400	-	-	V	I <sub>R</sub> = 100μA
V <sub>F</sub> Forward Voltage	-	1.19	1.3	V	I <sub>F</sub> = 8A
	-	0.94	1.0	V	I <sub>F</sub> = 8A, T <sub>J</sub> = 150°C
I <sub>R</sub> Reverse Leakage Current	-	0.2	10	μA	V <sub>R</sub> = V <sub>R</sub> Rated
	-	20	500	μA	T <sub>J</sub> = 150°C, V <sub>R</sub> = V <sub>R</sub> Rated
C <sub>T</sub> Junction Capacitance	-	14	-	pF	V <sub>R</sub> = 400V
L <sub>S</sub> Series Inductance	-	8.0	-	nH	Measured lead to lead 5mm from package body

**Dynamic Recovery Characteristics @ T<sub>J</sub> = 25°C, Per Leg (unless otherwise specified)**

Parameters	Min	Typ	Max	Units	Test Conditions	
t <sub>rr</sub> Reverse Recovery Time	-	35	60	ns	I <sub>F</sub> = 1.0A, di <sub>F</sub> /dt = 50A/μA, V <sub>R</sub> = 30V	
	-	43	-		T <sub>J</sub> = 25°C	I <sub>F</sub> = 8A V <sub>R</sub> = 200V di <sub>F</sub> /dt = 200A/μs
	-	67	-		T <sub>J</sub> = 125°C	
I <sub>RRM</sub> Peak Recovery Current	-	2.8	-	A	T <sub>J</sub> = 25°C	
	-	6.3	-		T <sub>J</sub> = 125°C	
Q <sub>rr</sub> Reverse Recovery Charge	-	60	-	nC	T <sub>J</sub> = 25°C	
	-	210	-		T <sub>J</sub> = 125°C	

**Thermal - Mechanical Characteristics**

Parameters	Min	Typ	Max	Units
T <sub>J</sub> Max. Junction Temperature Range	- 65	-	175	°C
T <sub>Stg</sub> Max. Storage Temperature Range	- 65	-	175	
R <sub>thJC</sub> Thermal Resistance, Junction to Case Per Leg	-	1.8	2.0	°C/W
R <sub>thJA</sub> ① Thermal Resistance, Junction to Ambient Per Leg	-	-	50	
R <sub>thCS</sub> ② Thermal Resistance, Case to Heatsink	-	0.5	-	
Weight	-	2.0	-	g
	-	0.07	-	(oz)
Mounting Torque	6.0	-	12	Kg-cm
	5.0	-	10	lbf.in
Marking Device	16CTU04S		Case style D <sup>2</sup> Pak	
	16CTU04-1		Case style TO-262	

① Typical Socket Mount

② Mounting Surface, Flat, Smooth and Greased

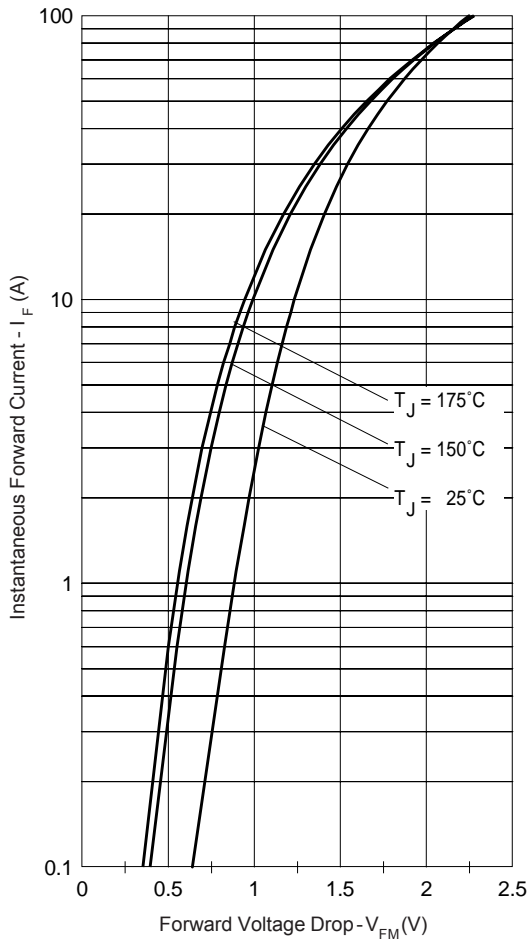

Fig. 1 - Typical Forward Voltage Drop Characteristics

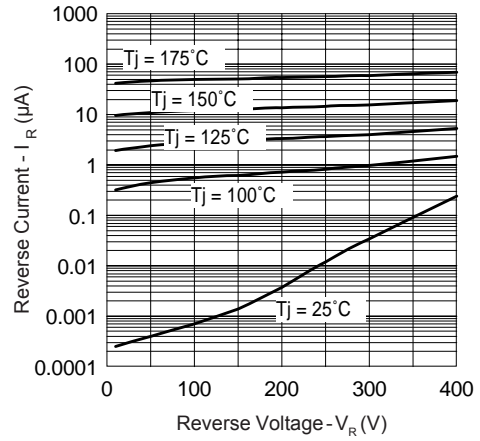

Fig. 2 - Typical Values Of Reverse Current Vs. Reverse Voltage

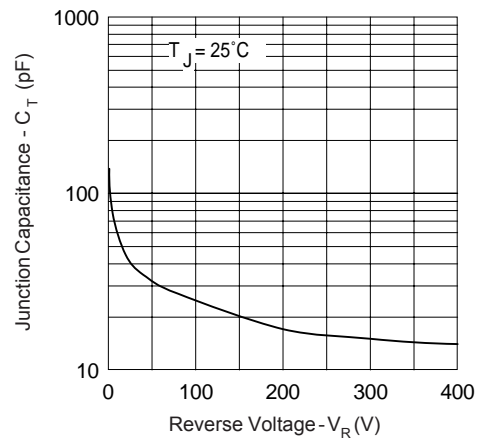

Fig. 3 - Typical Junction Capacitance Vs. Reverse Voltage

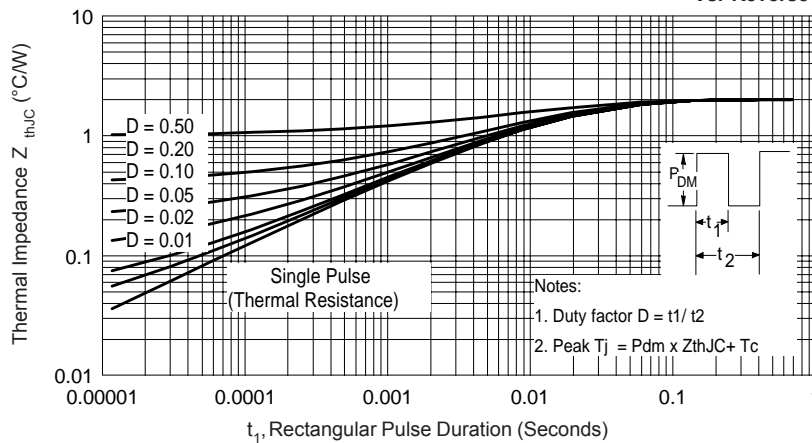

Fig. 4 - Max. Thermal Impedance  $Z_{thJC}$  Characteristics

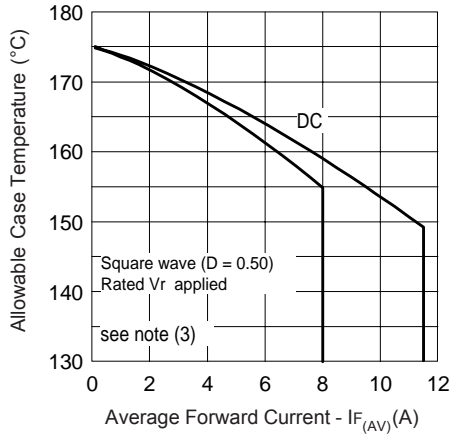

Fig. 5 - Max. Allowable Case Temperature Vs. Average Forward Current

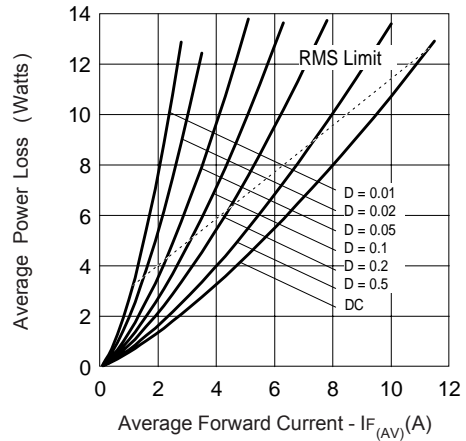

Fig. 6 - Forward Power Loss Characteristics

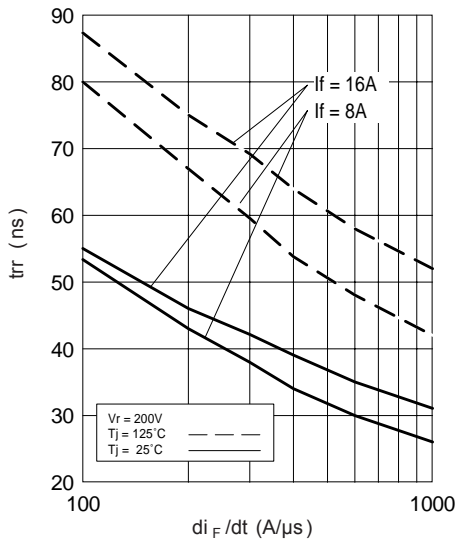

Fig. 7 - Typical Reverse Recovery vs.  $di_F/dt$

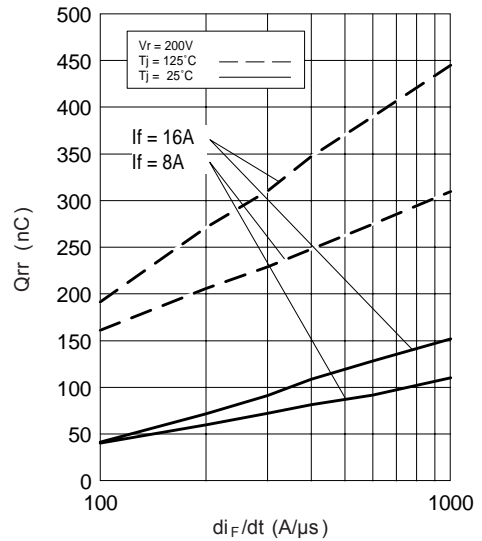

Fig. 8 - Typical Stored Charge vs.  $di_F/dt$

(3) Formula used:  $T_C = T_J - (P_d + P_{d_{REV}}) \times R_{thJC}$ ;

$P_d$  = Forward Power Loss =  $I_{F(AV)} \times V_{FM} @ (I_{F(AV)} / D)$  (see Fig. 6);

$P_{d_{REV}}$  = Inverse Power Loss =  $V_{R1} \times I_R (1 - D)$ ;  $I_R @ V_{R1}$  = rated  $V_R$

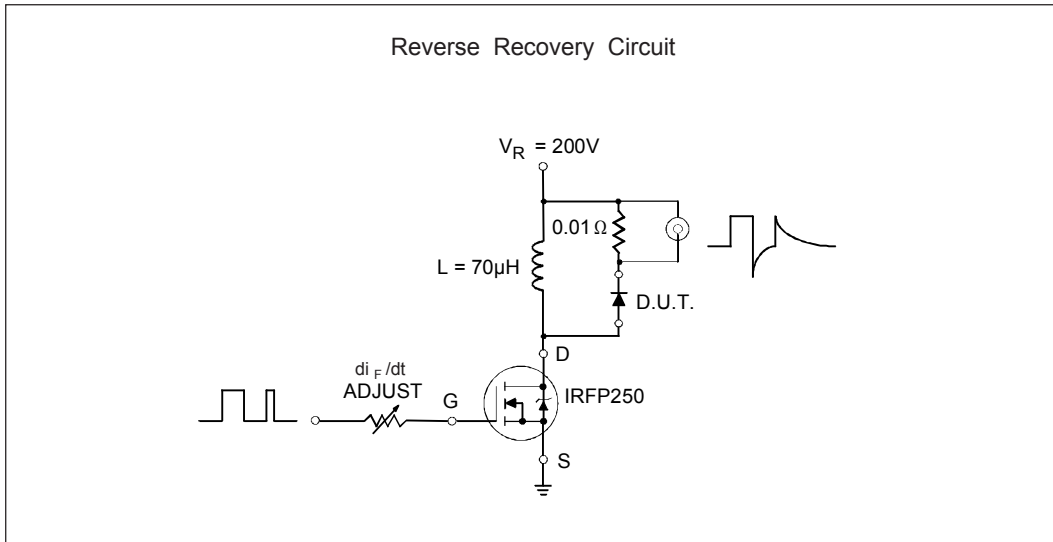

Fig. 9- Reverse Recovery Parameter Test Circuit

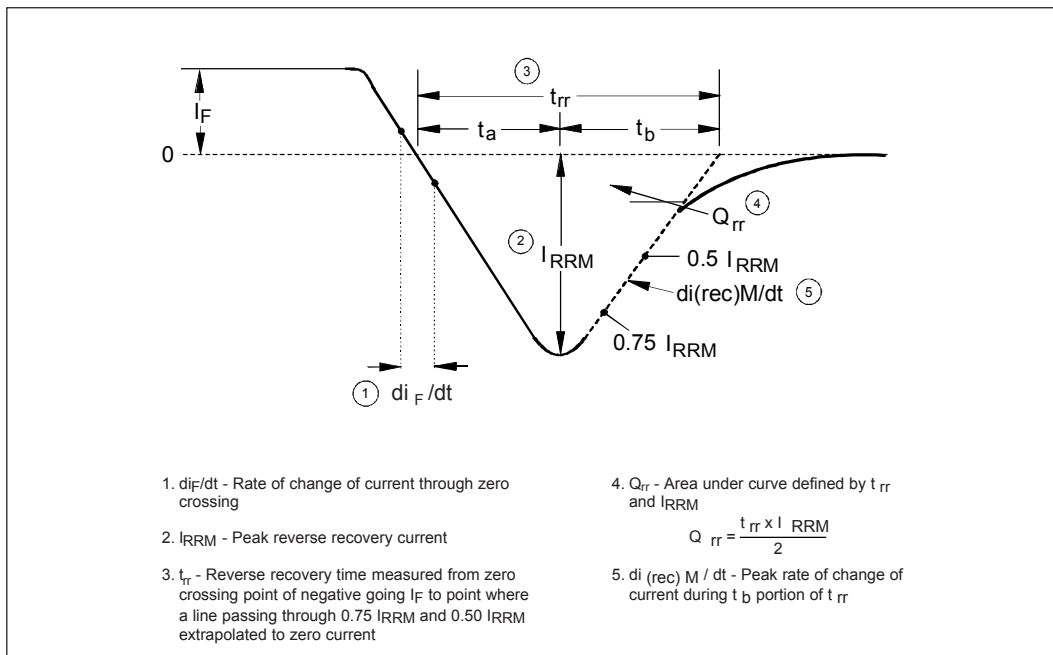
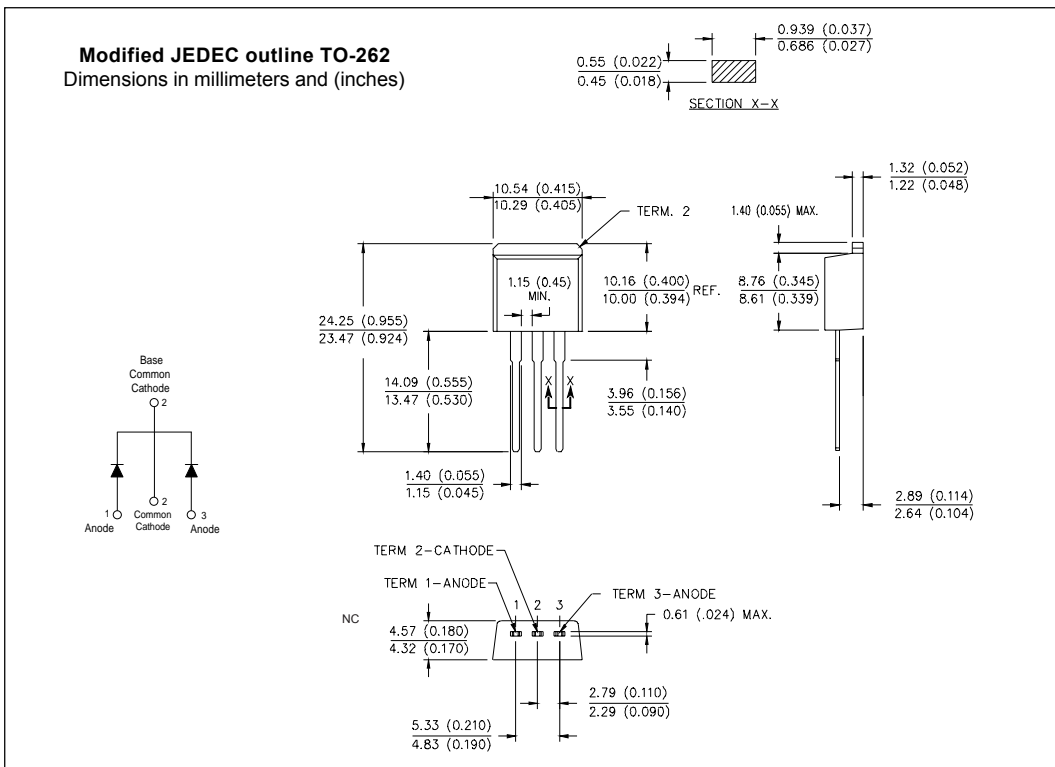
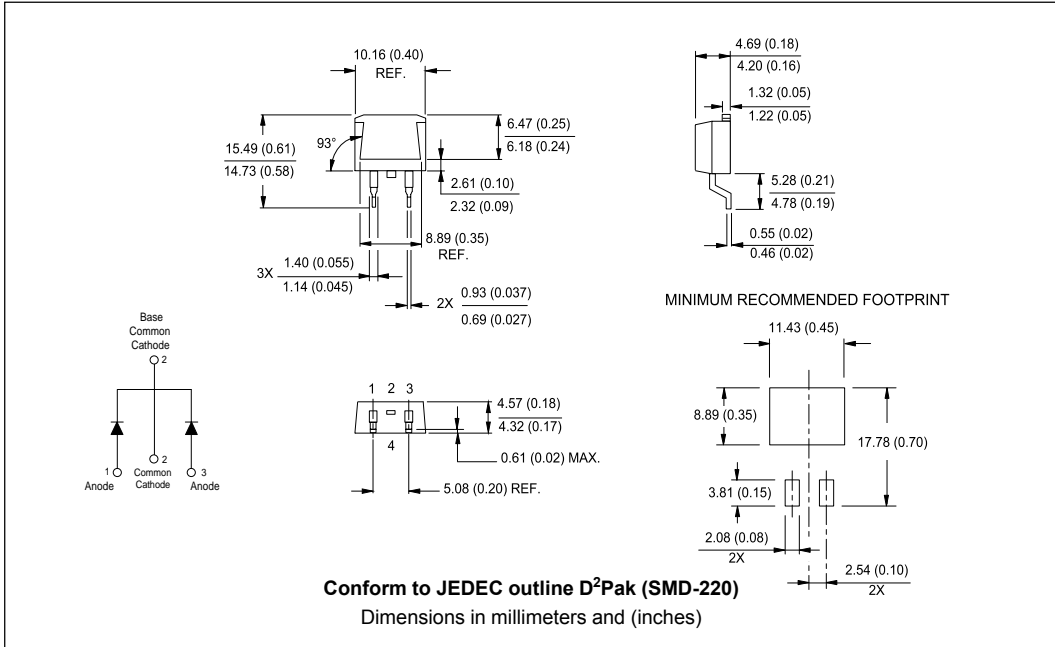

Fig. 10 - Reverse Recovery Waveform and Definitions

Outlines Table



Part Marking Information

**D<sup>2</sup>PAK**

EXAMPLE: THIS IS A 16CTU04S  
 LOT CODE 8024  
 ASSEMBLED ON WW 02, 2000

Note: "P" in assembly line  
 position indicates "Lead-Free"

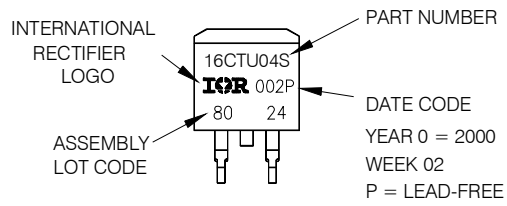

**TO-262**

EXAMPLE: THIS IS A 16CTU04-1  
 LOT CODE 8024  
 ASSEMBLED ON WW 02, 2000

Note: "P" in assembly line  
 position indicates "Lead-Free"

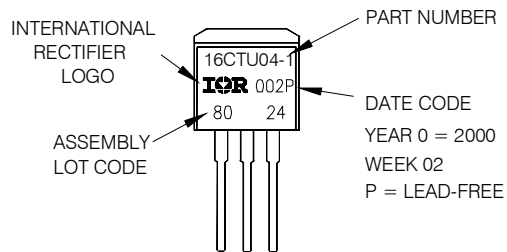

Tape & Reel Information

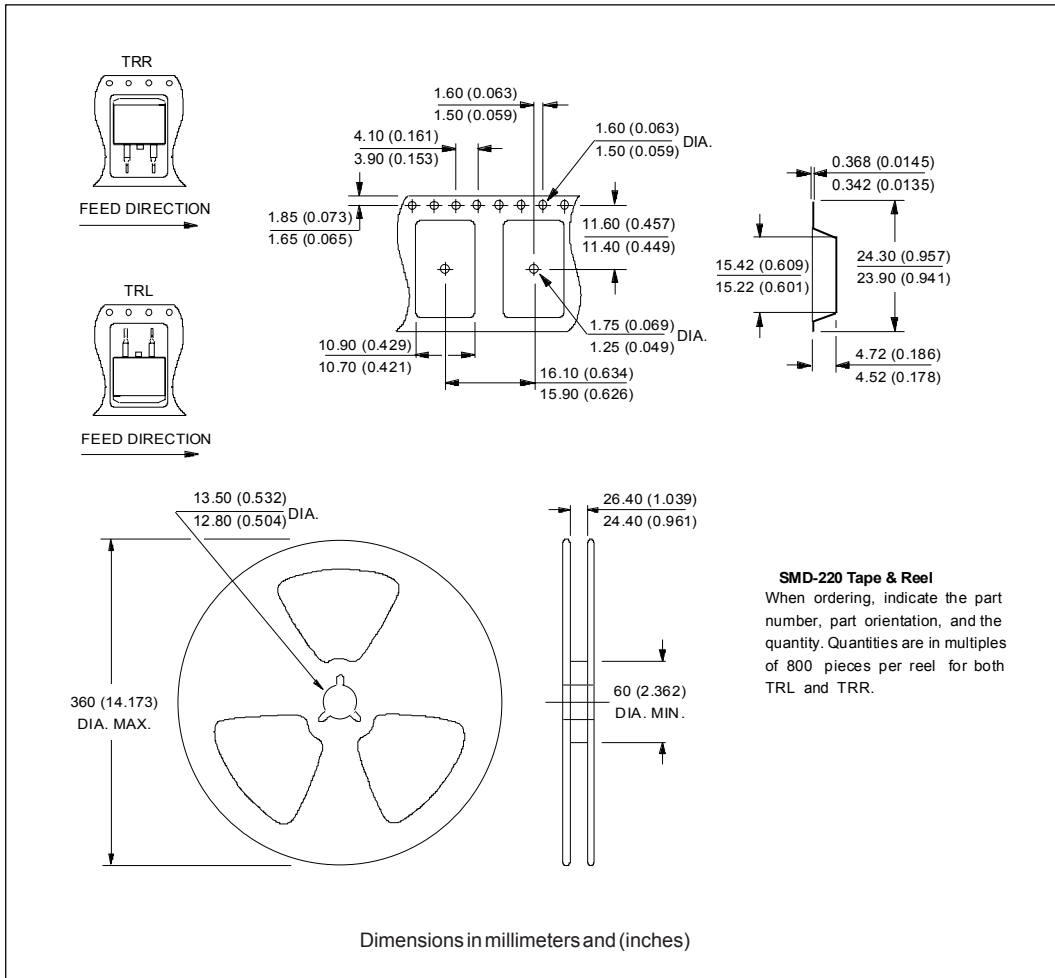



Ordering Information Table

Device Code									
	<table border="1" style="margin: auto;"> <tr> <td style="padding: 5px;">16</td> <td style="padding: 5px;">C</td> <td style="padding: 5px;">T</td> <td style="padding: 5px;">U</td> <td style="padding: 5px;">04</td> <td style="padding: 5px;">S</td> <td style="padding: 5px;">TRL</td> <td style="padding: 5px;">PbF</td> </tr> </table>	16	C	T	U	04	S	TRL	PbF
16	C	T	U	04	S	TRL	PbF		
	<table style="margin: auto;"> <tr> <td style="text-align: center;">①</td> <td style="text-align: center;">②</td> <td style="text-align: center;">③</td> <td style="text-align: center;">④</td> <td style="text-align: center;">⑤</td> <td style="text-align: center;">⑥</td> <td style="text-align: center;">⑦</td> <td style="text-align: center;">⑧</td> </tr> </table>	①	②	③	④	⑤	⑥	⑦	⑧
①	②	③	④	⑤	⑥	⑦	⑧		
<b>1</b>	- Current Rating (16A)								
<b>2</b>	- C = Common Cathode								
<b>3</b>	- T = TO-220, D <sup>2</sup> Pak								
<b>4</b>	- U = Ultrafast Rectifier								
<b>5</b>	- Voltage Rating (04 = 400V)								
<b>6</b>	- <ul style="list-style-type: none"> <li>• S = D<sup>2</sup>Pak</li> <li>• -1 = TO-262</li> </ul>								
<b>7</b>	- <ul style="list-style-type: none"> <li>• none = Tube (50 pieces)</li> <li>• TRL = Tape &amp; Reel (Left Oriented, for D<sup>2</sup>PAK package)</li> <li>• TRR = Tape &amp; Reel (Right Oriented, for D<sup>2</sup>PAK package)</li> </ul>								
<b>8</b>	- <ul style="list-style-type: none"> <li>• none = Standard Production</li> <li>• PbF = Lead-Free</li> </ul>								

Data and specifications subject to change without notice.  
 This product has been designed and qualified for Industrial Level and Lead-Free.  
 Qualification Standards can be found on IR's Web site.